



OWNER'S MANUAL

M-30 Series



Installation & Service Instructions

This manual contains precautionary statements only relating to worker safety. Persons handling equipment or systems should be instructed to conduct themselves in a safe manner at all times. All potential hazards of dust and mist control systems are impossible to list, therefore we recommend that the services of a professional electrician/installer be obtained. A fire protection expert should be obtained in the event this equipment is intended for use where there is potential risk of fire or fire propagation. Refer to appropriate authorities, and discuss your intended use of equipment with your Air King distributor.

Persons handling or working around this equipment should be trained in proper safety procedures, and conduct themselves in a safe manner.

RETAIN THIS MANUAL FOR FUTURE REFERENCE

Specifications for the Air King M-30 Series

SPECIFICATIONS	M-30 (Standard)	M-30CF (Charcoal Filter)	M-30WA (Wrap-Around)
Dimensions	24"W x 24"T x 72"L		24"W x 25"T x 108"L
Weight	180 lbs	200 lbs	250 lbs
Pre-filter (Merv 10)	(2) 24x24x4" Pleated		(2) Poly pre-filters & (2) 4" pleated
Primary Bag Filter (Merv 11 standard) (CF model uses Merv 15)	(2) 65%, 22" 8 Pocket Bags (130 ft ²)	(2) 95%, 15" 12 Pocket Bags (145 ft ²) with (2) 2" Charcoal after filters	(2) 65%, 22" 8 Pocket Bags (130 ft ²)
Volume (CFM)	3000 CFM	2500 CFM	3000 CFM
Motor	3/4 HP PSC with thermal overload; 115/1/60; 9.5 amps		
Blower	10 x 10 Direct Drive, 2 Speed		
Power	10' power cord, single phase		
Construction/Paint	16 Gauge steel; River Blue chemical resistant powder coating		
Noise Level @ 5' (dBA)	70 dBA		

Available Options:

95% 8 Pocket Bag Filter (Merv 15)
Eyebolts for hanging (set of 4qty)
Magnehelic pressure gauge (monitors filter loading)
Strut Channel hanging brackets
"L" mounting brackets
Chain, Q-links & Eyebolts Kit
Gas Phase Blend Filters (in place of charcoal)

Silencer w/ 4-way louver (reduces sound by 6-8 decibels)
Silencer w/ non-directional grill (reduces sound by 10-12 decibels)
208-230v or 277v single phase motors
Washable Aluminum Mesh pre-filter(replaces pleated)
Ionizer module (Needlepoint Bipolar Ionizer)

Warranty: **3 years on all parts, does not include filters.**

AIR KING LIMITED WARRANTY

Air King warrants all products sold, only to purchasers for use in business or for resale, against defects in workmanship or materials under normal use for three years (does NOT include filters) after date of purchase from Air King Filtration, Inc. This three year warranty does include standard warranties from purchased parts such as blowers, motors, valves, etc. All purchased items will fall under the manufacturers' standard warranty. Any part which is determined to be defective in material or workmanship and returned to Air King Filtration, Inc. or authorized service facility, as Air King Filtration, Inc. designates, shipping cost prepaid, will be, as the exclusive remedy, repaired or replaced, at Air King Filtration, Inc. option. Any liability for consequential and incidental damage is expressly disclaimed. Air King Filtration, Inc. liability, in all events, is limited to and shall not exceed, the purchase price paid. Title and risk of loss pass to buyer on delivery to the common carrier. If product is damaged in transit, recipient must file claim with carrier. Air King Filtration, Inc. will make a good faith effort for prompt correction or other adjustments with respect to any product that proves to be defective within the warranty period.

 **WARNING!**

This manual provides critical safety instructions on the proper setup, operation, maintenance, and service of this machine/tool. Save this document, refer to it often, and use it to instruct other operators.

Failure to read, understand and follow the instructions in this manual may result in fire or serious personal injury—including amputation, electrocution, or death.

The owner of this machine/tool is solely responsible for its safe use. This responsibility includes but is not limited to proper installation in a safe environment, personnel training and usage authorization, proper inspection and maintenance, manual availability and comprehension, application of safety devices, cutting/sanding/grinding tool integrity, and the usage of personal protective equipment.

The manufacturer will not be held liable for injury or property damage from negligence, improper training, machine modifications or misuse.

 **WARNING!**

Some dust created by power sanding, sawing, grinding, drilling, and other construction activities contains chemicals known to the State of California to cause cancer, birth defects or other reproductive harm. Some examples of these chemicals are:

- **Lead from lead-based paints.**
- **Crystalline silica from bricks, cement and other masonry products.**
- **Arsenic and chromium from chemically-treated lumber.**

Your risk from these exposures varies, depending on how often you do this type of work. To reduce your exposure to these chemicals: Work in a well ventilated area, and work with approved safety equipment, such as those dust masks that are specially designed to filter out microscopic particles.

SAFETY

Follow all electrical and safety codes as well as the National Electrical Code (NEC), the National Fire Protection Association (NFPA), and the Occupational Safety and Health Administration (OSHA) requirements. Only qualified personnel should perform electrical connections and wiring.

National Fire Protection Association (NFPA) standards require specific duct design and dust collector configuration when collecting potentially reactive metal dusts, such as aluminum, magnesium, and other materials. NFPA also covers other dusts such as grain and plastics, etc. A guideline for determining the precautions to be taken can be found on the NFPA website (www.nfpa.org), by contacting them at NFPA, 1 Batterymarch Park, Quincy, MA, 02269, or via phone at 1-800-344-3555. Other NFPA standards may apply to your specific application.

Additional references are the Uniform Building Code and the Uniform Mechanical Code.

WARNING!

- **Avoid mixing combustible materials such as (but not limited to) buffing lint, paper / wood dust, aluminum or magnesium with dust generated from the grinding of ferrous materials. This creates a potential for fire due to the mixing of sparks and combustible materials.**
- **Under no conditions should any person be allowed to put lit cigarettes, or any burning object, into this or any dust/mist control system.**
- **Installation of this unit in applications where there is a chance for heated and/or flammable materials to enter the unit should be evaluated to determine if a fire protection/extinguishing system should be installed. Federal, state or local codes, and/or requirements as defined by organizations such as NFPA, OSHA, or your insurance carrier, may require such a system. Air King or your distributor may offer general guidelines for reference with such an installation; however, any suggestions provided are purely informational in nature. Final installation design is the full responsibility of the filtration unit owner/user.**

DISCLAIMER

Although instructions and recommendations are included for installation of your mist or dust collector equipment, the manufacturer does not assume responsibility for the installation of this equipment nor shall be held liable for direct or consequential damages resulting from improper methods, structural failure or inadequate supports. This manual contains precautionary statements only relating to worker safety. Persons handling equipment or systems should be instructed to conduct themselves in a safe manner at all times. All potential hazards of dust and mist control systems are impossible to list, therefore we recommend that the services of a professional electrician/installer be obtained. A fire protection expert should be obtained in the event this equipment is intended for use where there is potential risk of fire or fire propagation. Refer to appropriate authorities, and discuss your intended use with your Air King distributor.

Initial Inspection

Upon receipt of your new Air King unit(s) you should immediately inspect the shipment for damages or possible shortages, and verify that what is on the packing list is included. If shipping damage is present or a shortage has occurred, note this accordingly on the freight carrier's proof of delivery/freight bill prior to signing it, retaining a copy for your records. Immediately document the load via digital photos, and forward these to your Air King distributor, contacting them for further guidance. If the shipment is opened at a later time and there is concealed damage to the unit/items inside, please contact your Air King distributor for guidance on providing the proper information to file a concealed damage claim with the delivery carrier.

Failure to take these steps in a timely manner may result in the inability for the manufacturer, shipper or your distributor to initiate the proper freight/shipping claims and may result in their inability to correct the problem. All possible steps will be taken to resolve any freight related issues in a timely manner.

Installation & Mounting

All installations must meet all electrical or mechanical building codes that may apply in your particular area. If there are no local requirements, you should follow the National requirements. Specific installation instructions may also be furnished by your distributor contact.

There are many different ways to mount your units. The most common is via eyebolts in the top of the unit, supporting them from the ceiling structure with four chains (see Option 1, page 5). If using this method, and your unit has not been purchased with factory-installed eyebolts, you can do this yourself. Drill 4 holes through the top of the unit approximately 8" in from each end and 3/4" in from each side of the unit. Use at least 5/16" eyebolts with nuts and washers on both the inside and outside of the unit. The top end of the chains must be secured to the ceiling structure in a safe and acceptable manner.

All chains, hooks, bolts or other items used for installation must be at least strong enough to support 4x the weight of each unit. Unit weights are as follows:

- Air King M-30 180 lbs
- Air King M-30CF 200 lbs
- Air King M-30WA 250 lbs

Units can also be mounted by using wall mounting/L-brackets (see Option 2, page 5), strut channel (see Option 3, page 5), threaded rod, or units can be affixed to existing shelving/racking. Whatever means of mounting your units, it is your responsibility to ensure that all hardware or other support pieces being used are sufficiently load rated to handle the weight of the units.

M-30 Installation / Mounting Options

OPTION 1 : SUSPENDED WITH CHAINS & EYEBOLTS



OPTION 2 : WALL MOUNTING BRACKETS

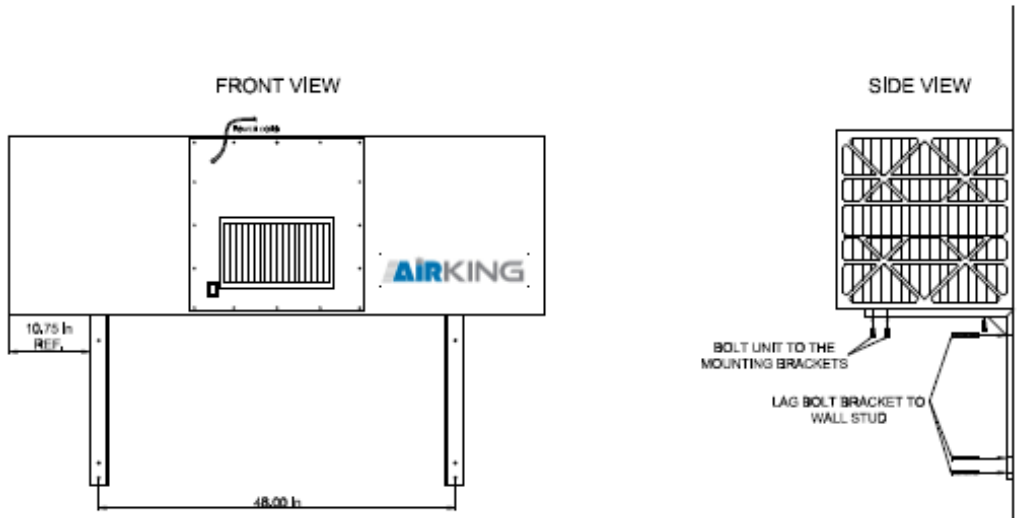

OPTION 3 : STRUT-CHANNEL HANGING BRACKETS

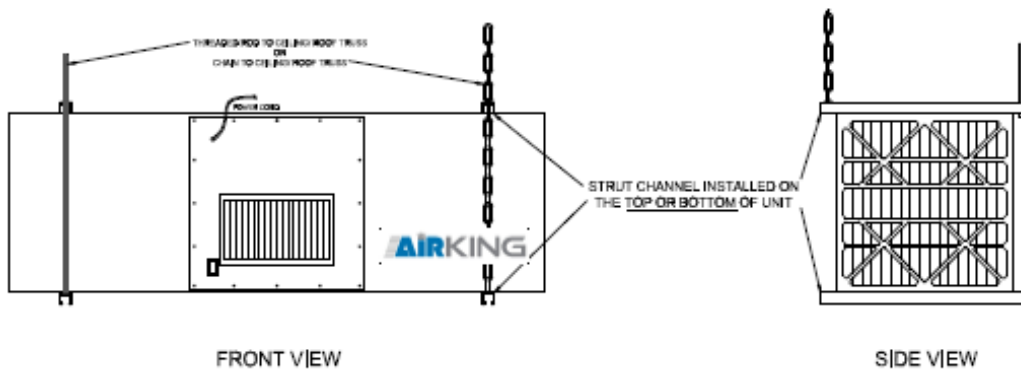

Unit Placement / Air Flow Patterns

It is essential to properly install your air cleaners to maximize the airflow in your space and best capture nuisance particulates. In most cases we recommend installing the M-30 unit(s) in positions that can criss-cross the air (see below), exchanging air back and forth between units. If a single unit is installed in an area, we suggest installing in a position that will best capture the source of the nuisance particulates, and discharge clean air into a more desired area. In all cases, the units are most effective in your space when your “dirty air” is directed toward the intake of the unit(s). Please see the illustrations below showing examples of different space sizes and layout configurations.

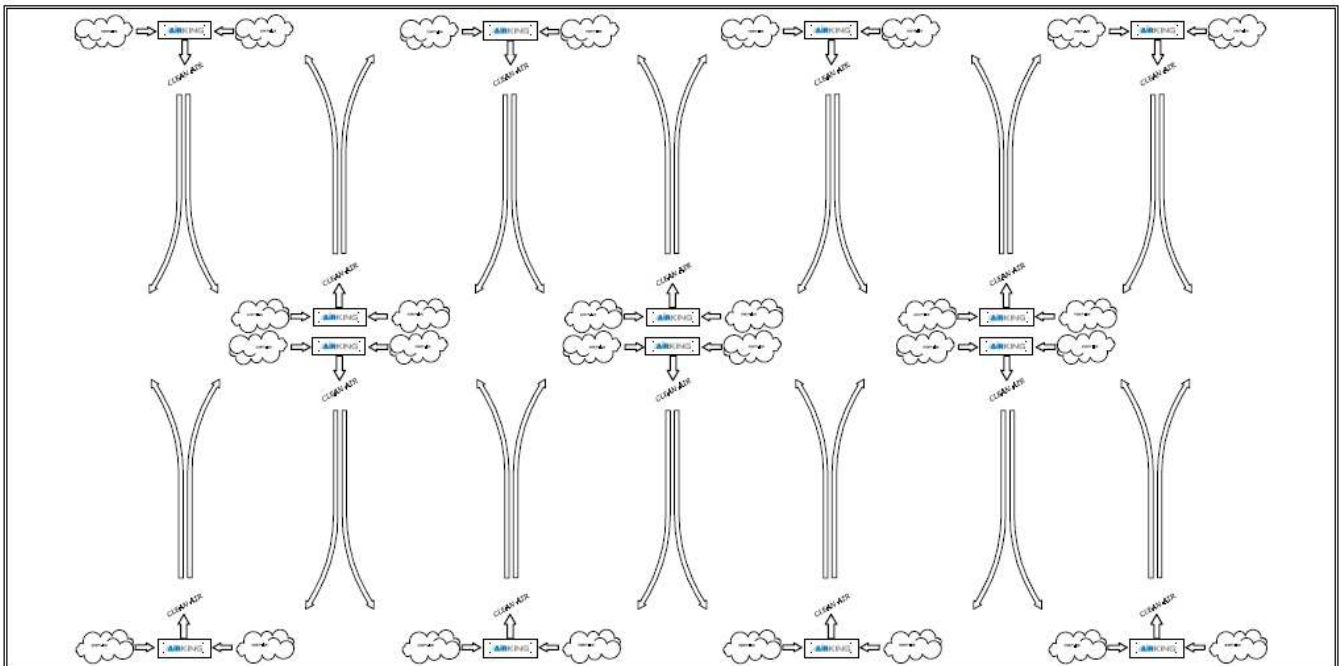
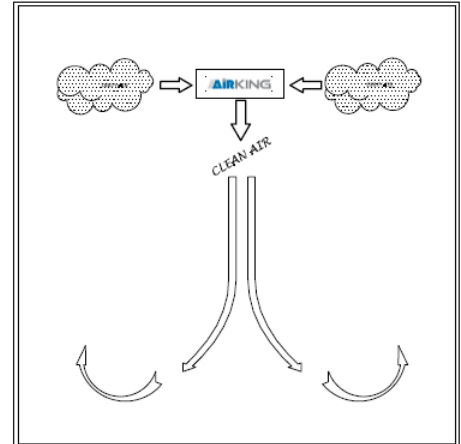
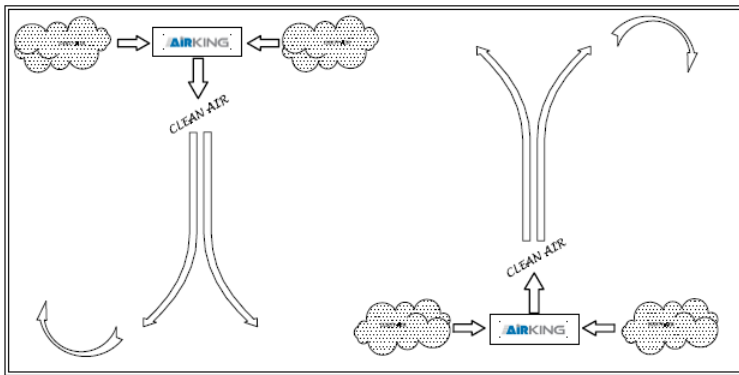

Operation

Air King industrial air cleaners are a valuable tool in capturing most airborne nuisance particulate. Our self-contained filtration units continuously pull contaminated air through multiple stages of highly efficient micro-glass filters. The filtered air is then re-circulated back into the working environment without the need for duct work. This results in a cleaner, healthier atmosphere for employees, while saving you money by keeping heated or air-conditioned air inside your facility.

The Air King M-30 series units are extremely versatile and can be used individually in smaller spaces, or in multiples for larger areas to establish positive airflow patterns that will enhance the effectiveness of the units. The T-style configuration of these units has inlets on both ends and exhausts the filtered air from the center of the unit.

For best results, please contact your Air King distributor for guidance regarding unit placement and use in your specific environment.

Filters & Filter Maintenance

All units are equipped with disposable/replaceable media type filters. Please refer to the specifications table on page #2 of this manual for filter information specific to your unit. The filters in your new Air King unit have been selected by your representative for your specific needs. All filters are disposable and easy to service.

The media type filters used in your unit actually become more efficient as they load with contamination. However, as the filters load up the air flow volume will decrease and eventually will reach a point where they must be replaced to restore the original air flow. All pleated pre-filters and internal bag filters are disposable and made to imbed particulates in them. These filters are NOT washable.

Before changing your filters, power down the unit. Remove the pre-filter by simply pulling this from the intake end(s) of the unit. Behind the pre-filter you will see the multi-pocket bag filter. This can also be removed by pulling it out by the frame of the filter. New filters can now be installed, and old filters disposed of.

When installing new filters, the pockets of the bag filter, and the pleats of the pre-filter should be in a vertical position. Be sure the cloth part of the bag filter does not bunch up between the bag frame and the installed filter stops on the cabinet. The pre-filter should be installed with the wire mesh to the inside of the unit, and the pleats in a vertical position. Turning the unit on just prior to installing new filters will help to pull them into place. Do not operate your units without filters for more than a few minutes at a time.

Not all replacement filters are "created equal." The filters used in your new Air King unit are some of the highest quality available. Please contact your distributor for guidance and purchase of replacement filters for your Air King unit(s).

General Note: Periodic Cleaning of Cabinet

Occasional cleaning of the cabinet interior should be done to keep unit free of unwanted materials. Power down the unit, remove filters, and inspect the cabinet interior. Remove any foreign materials by hand and/or with a vacuum, wipe interior down, and clean all filter seating surfaces. Re-install filters and continue with use.

Magnehelic Pressure Gauge (optional)

This option can be purchased with the unit to help determine when to change the filters. Upon initial startup of your unit, the pressure reading should be in the .25-.40" range (standard units). As the filters fill with contaminants, the needle on the gage will rise. We recommend changing filters when the pressure reading is between .60 – .75" above the initial reading with clean filters. It is normal to change the pleated pre-filters 2-3x (or more) as often as the bag filter(s). If, after changing out the pleated pre-filter(s) there is no longer a significant drop in pressure, then it is time to change the internal bag filter(s). Readings may vary depending upon the contaminants and filter configurations. Please consult your Sales Engineer for further information.

Louvers

Four-way directional louvers are provided on all standard units to permit you to some general control in directing the discharge air. Proper positioning of the units, and adjustment of the directional louvers, will allow you to maximize your airflow pattern to allow the units to perform at their best. These directional louvers can also aid in directing heated air down into the work space of your shop, helping to reduce overall heating costs within your facility.

Motor

All direct drive motors are protected with automatic restart, thermal overload protection. Please see page #9 for wiring diagram. All belt-driven units must be protected externally.

M-30 WIRING DIAGRAM

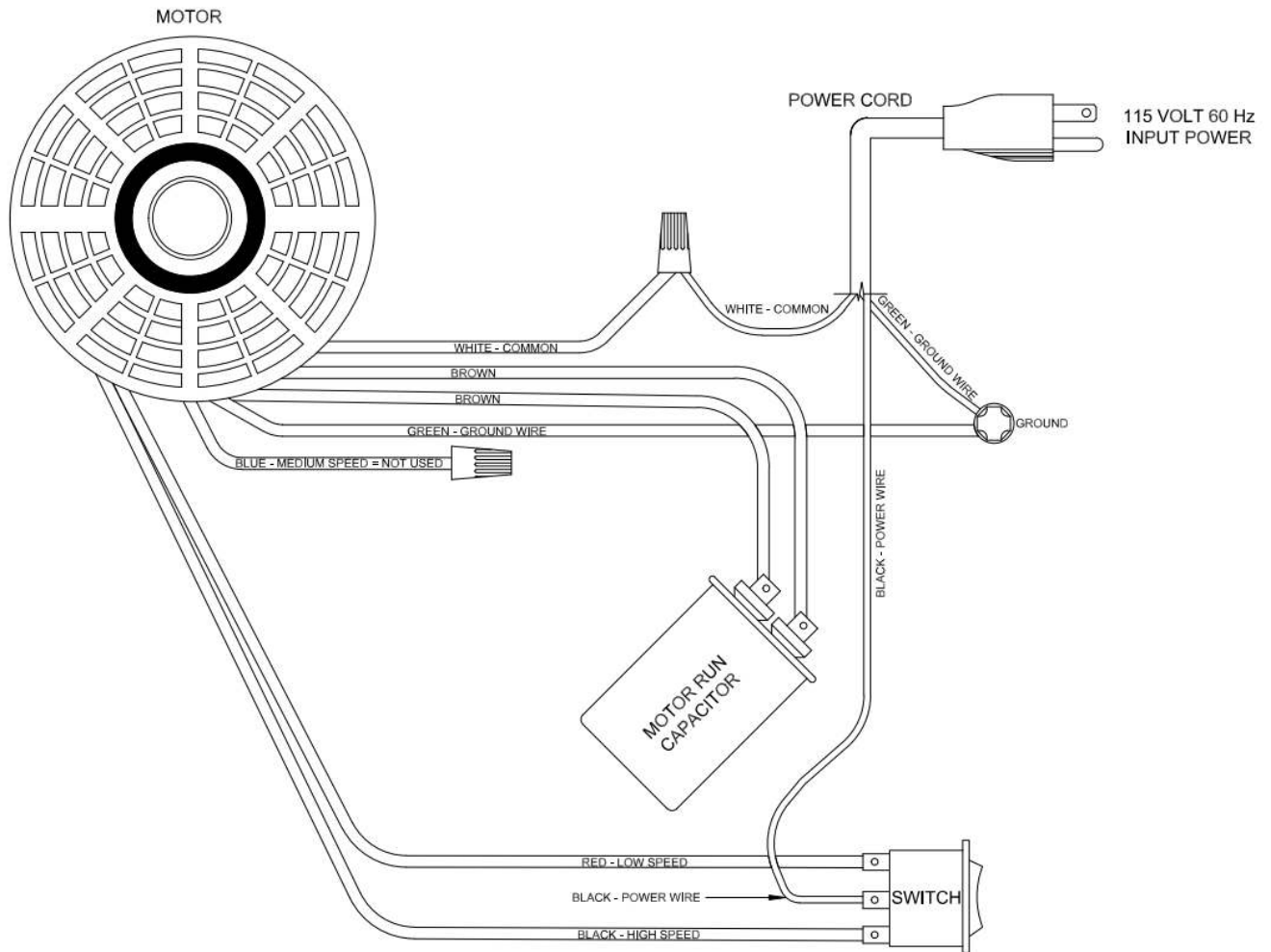

ALWAYS follow local, state and national electrical code requirements specific to your area, and before undertaking any electrical project, contact your local electrical authority to ensure that you comply with all policies, warranties, regulations and authorities concerning this work.

Troubleshooting

Problem	Possible Causes – What To Do
<p>Motor fails to start/stalls/does not come up to speed.</p>	<p><u>Low or No Voltage:</u></p> <ul style="list-style-type: none"> • Check that the unit is plugged into correct power source. <p><u>Circuit Overload:</u></p> <ul style="list-style-type: none"> • Check that the power source breaker/fuse has not been tripped/blown. <p><u>Faulty Connections:</u></p> <ul style="list-style-type: none"> • Check the motor wiring connections, ensure all are in place and firmly connected. (see wiring diagram – page 9) <p><u>Defective Starting Capacitor:</u></p> <ul style="list-style-type: none"> • Replace with original manufacturer parts. (see page 11) <p><u>Defective Switch:</u></p> <ul style="list-style-type: none"> • Replace with original manufacturer parts. (see page 11) <p><u>Overload:</u></p> <ul style="list-style-type: none"> • Check that the filters are in proper position, and not excessively dirty or blocked. <p><u>Defective Motor:</u></p> <ul style="list-style-type: none"> • Replace with original manufacturer parts. (see page 11)
<p>Motor makes a irregular noise/excessive vibration.</p>	<p><u>Loose hardware/obstructions in blower:</u></p> <ul style="list-style-type: none"> • Check for loose blower wheel on motor shaft – tighten if necessary. • Check for loose motor mounts – tighten if necessary. • Check all hardware, be sure everything is tight and held firmly in place. • Be sure that the blower wheel can spin freely unobstructed by any foreign materials/objects.
<p>Contaminants blowing through unit.</p>	<p><u>Filter problems:</u></p> <ul style="list-style-type: none"> • Check for torn or damaged filters. • Check for dirty or blocked filters. • Check that filters are correctly installed.
<p>Low or no airflow.</p>	<p><u>Filter problems:</u></p> <ul style="list-style-type: none"> • Check for dirty or blocked filters. • Check that filters are correctly installed. <p><u>Motor/blower spinning in the wrong direction:</u></p> <ul style="list-style-type: none"> • Reverse the directional wire connections (purple and yellow). • Be sure the blower wheel is spinning bottom-to-top, when viewing thru the exhaust grate/louvers.

When performing any of the above troubleshooting – **USE CAUTION**, and **BE SURE THAT THE UNIT HAS BEEN DISCONNECTED FROM THE POWER SOURCE**. Follow all company safety policies and/or proper lockout/tagout procedures.

After performing the above TROUBLESHOOTING guide and the unit still fails to perform to specifications, please contact your AIR KING distributor or dealer for further assistance.

M-30 Replacement Parts

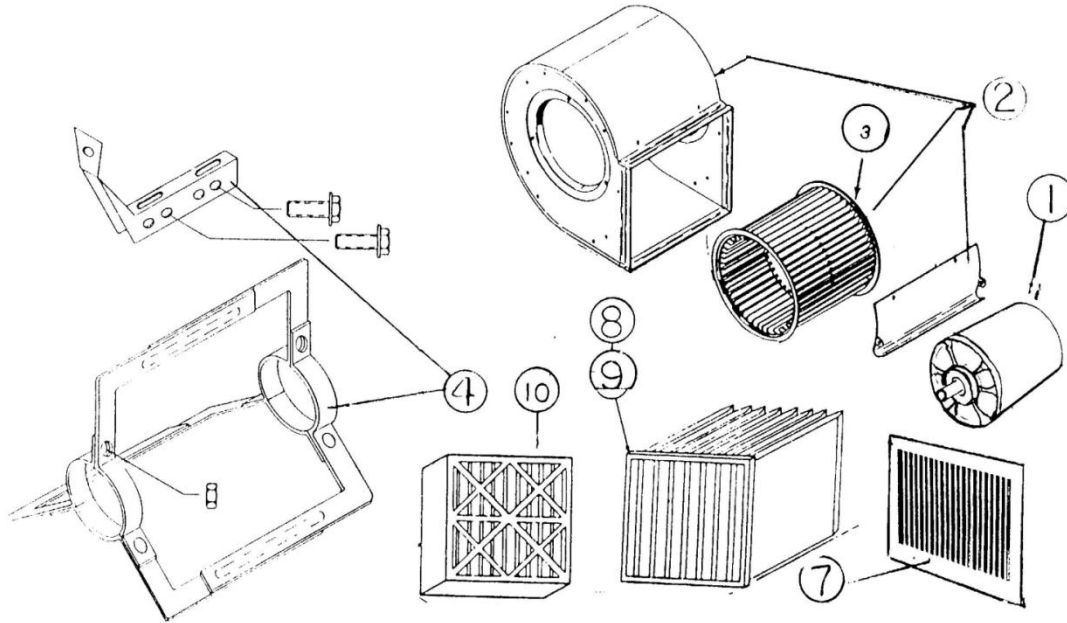

<u>ITEM</u>	<u>PART #</u>	<u>DESCRIPTION</u>
1	30-1000	3/4HP, 115V, Direct Drive Motor
2	30-1500	10" Complete Blower Assembly (housing & blower wheel)
3	30-1501	Blower Wheel ONLY (squirrel cage)
4	30-1502	Motor Mount (2 halves) & Hardware (direct drive only)
5	30-2000	2 Speed Switch
6	30-2002	Power Cord (10' finished length)
7	30-3000	4-way Adjustable Louver
8(a)	FL242422B65	24x24x22" 8-pocket Bag Filter (65% / MERV 11)
8(b)	FL242422B95	24x24x22" 8-pocket Bag Filter (95% / MERV 15)
9	FL242415B95	24x24x15" 12-pocket Bag Filter (95% - CF unit only)
10	FL242404P	4" Pleated Pre-filter
10*	FL242404M	4" Aluminum Mesh Pre-filter (optional)

TO ORDER REPLACEMENTS PARTS:

Contact your local distributor, or the manufacturer:

Air King Filtration, Inc.
 2800 Technology Parkway
 Cedar Falls, IA 50613
 Ph. (319) 266-5411
www.AirKingFiltration.com